

Servicing:

- This Pump, like all mechanical equipment, requires maintenance.
- Every six months the reservoir should be removed, taking care to clean the filters and reservoir thoroughly. We recommend this is done in the Spring and the Autumn, using an anti-bacterial wash.
- Take great care to replace the reservoir horizontally.

Troubleshooting:

Fault: The Pump runs all the time.

1. Is the float positioned with the magnet uppermost?
2. Is the reservoir lid (sensor) located firmly onto the reservoir, with the float located inside the reservoir, around the sensor column?
3. Is the plug at the end of the sensor cable correctly inserted into the pump case, and are the plug/socket terminals dry?
4. Is there any sludge inside the reservoir, preventing the float from resting on the bottom? (This may be the case if the pump has been in operation for some time. Clean using an anti-bacterial wash).
5. Is the pump overwhelmed with the volume of condensation? (If so, a larger pump is required).

Please note:

- After installation and during operation, if you notice air in the pipe between the reservoir and the pump, you have a siphoning problem (see page 4).
- The pump will only switch off when the float is resting flat on the bottom of the reservoir.

Fault: The Pump stops and starts, and makes a loud noise.

1. The water is siphoning back through the pump. Follow advice on page 4 to prevent back siphoning.

Fault: The Pump runs but does not pump any water.

1. Are there any air-leaks in the pipe between the reservoir and the pump? (Use cable ties to ensure an airtight seal).
2. Are the reservoir and the inlet tube free from sludge and debris?

Fault: The Pump isn't operating at all.

1. Is power reaching the pump? Is it correctly wired? Is the voltage correct?
2. Is the pump very hot? A thermal cut-out may have been activated, which will reset automatically once the pump has cooled down.

Aspen Pumps Limited, Apex Way, Hailsham, East Sussex, BN27 3WA, United Kingdom
Email: sales@aspenpumps.com Web: www.aspenpumps.com
Tel: +44 (0) 1323 848 842 Fax: +44 (0) 1323 848 847



mini orange pump

INSTRUCTION GUIDE



- Designed to be installed above a false ceiling where possible, behind wall-mounted evaporators or in the plastic conduit

- Quick and easy to install

- The Mini Orange will quietly and reliably pump condensation water to a maximum height of 8 metres

- Two reservoir options supplied for installation flexibility

Thank you for buying your new Mini Orange Pump.

This manual gives instructions on the correct installation, so it is important that you follow these instructions carefully. Please record the following information for your future reference:

Serial No.:

Date installed:

Location of pump:

sales@aspenpumps.com www.aspenpumps.com

Technical Data:

- Power supply 230V A or 20W
Alternative voltages available
- 1PH 50/60 Hz
- Volt-free N.O., N.C. 8A Resistive (5A INDUCTIVE)
- Hall effect semi conductor level sensors
- Water flow rate: 14 litres per hr at zero head
- Maximum recommended head: 8mtrs
- 33dB(A) @ 1 metre & 8 metre head
- CE marked
- Thermally protected pump.

In the box:

Remove the pump from its packaging and check that you have all the following items provided in the box:

- 1 x pump unit (52 x 122 x 38mm)
- 1 x assembled reservoir (40 x 75 x 40mm)
 - lid & sensor cable
 - float
 - filter
 - reservoir
- 1 x reservoir/submersible (40 x 75 x 40mm)
- 1 x 40mm orange silicone rubber tube
- 1 x 15mm o/d x 4mm i/d vinyl tube
- 1 x 1.5m x 9mm o/d x 6mm i/d vinyl tube
- 1 x 6mm → 4mm reducer
- 1 x 6-pin socket lead assembly
- 2 x 20mm x 50mm self-adhesive Velcro
- 4 x 300mm x 3.6mm cable ties

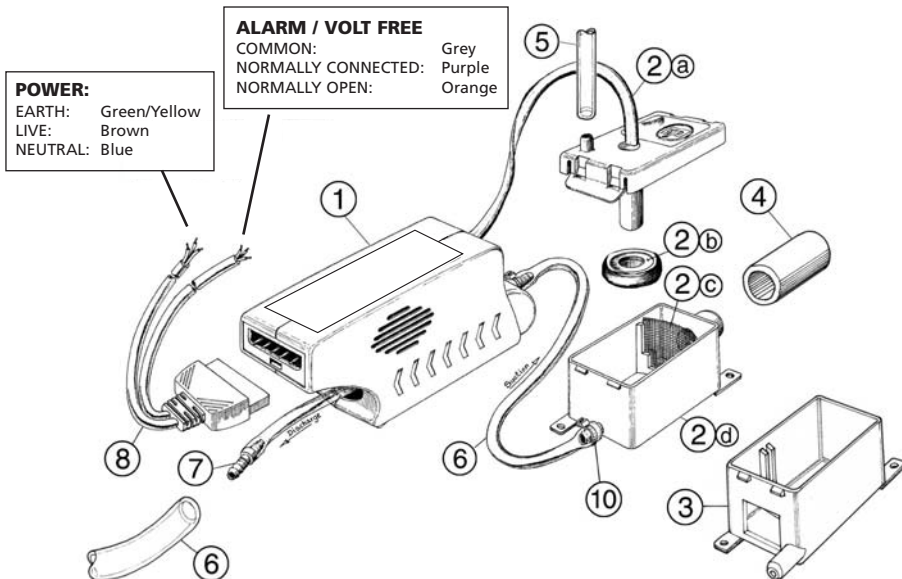

Typical Performance:

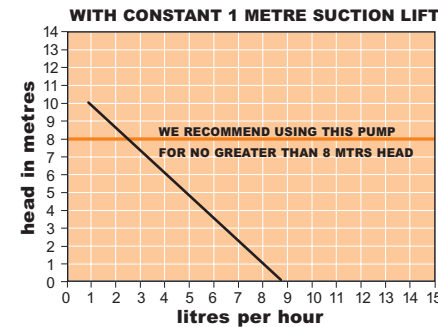
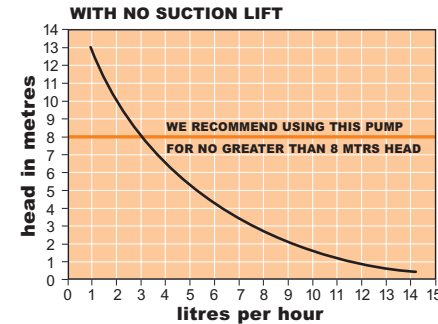

Product Safety:

- **CAUTION:** The Mini Orange Pump has been evaluated for use with water only.
- **WARNING:** Risk of electric shock. This pump is supplied with a grounding conductor and grounding type attachment plug. To reduce the risk of electric shock, be certain that it is connected only to a properly grounded, grounding type receptacle.
- Ensure the pump is disconnected from the mains supply before carrying out any adjustments or servicing.
- Always ensure the metal magnet in the float is facing upwards.
- Always ensure the reservoir is sitting flat and horizontal.
- The pump is ideal for most working and living environments. It is not recommended where the environment is oily or particularly dusty.

Preventing Siphoning: advice

- Cut discharge tube above water level of evaporator tray and direct end into large pipe

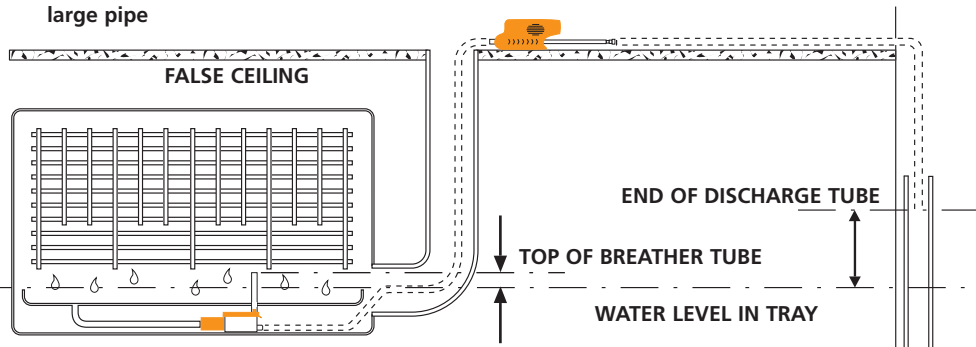

- More tube length horizontal than vertical

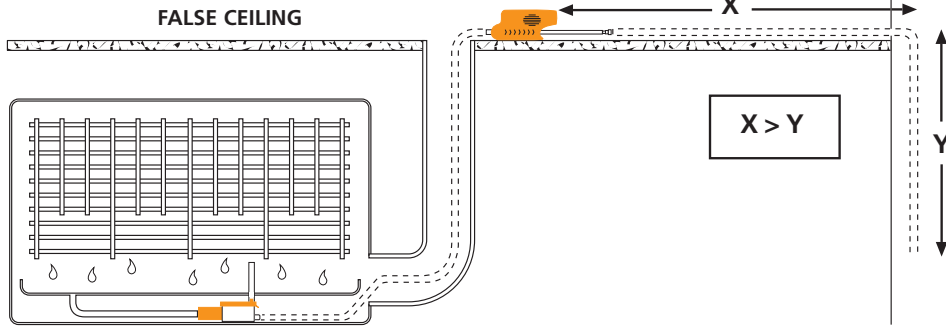

- Create increased resistance

- Add a loop

- Turn back on itself

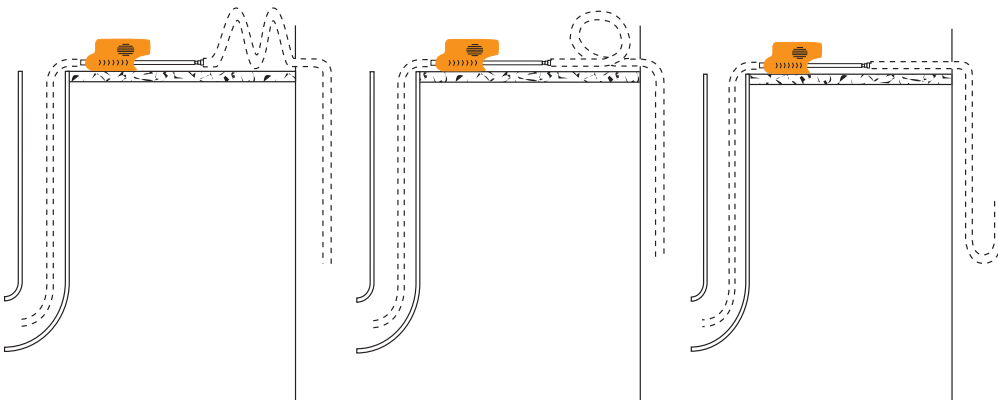

Installation:

- 1 Assess situation and choose either reservoir (A) or (B).

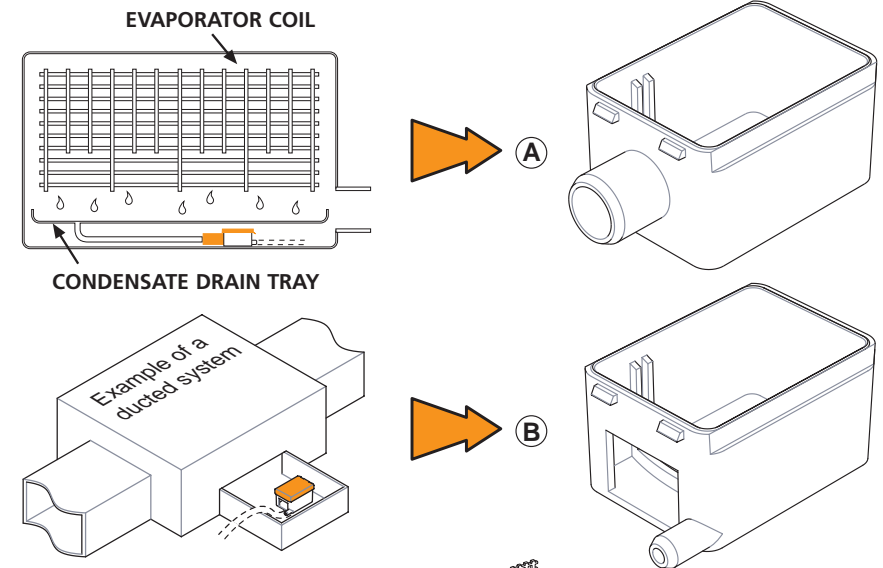

- 2 Place filter in chosen reservoir.

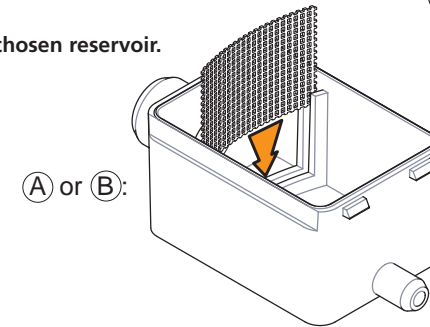

- 3 Position float in reservoir with magnet uppermost, and clip lid onto reservoir.

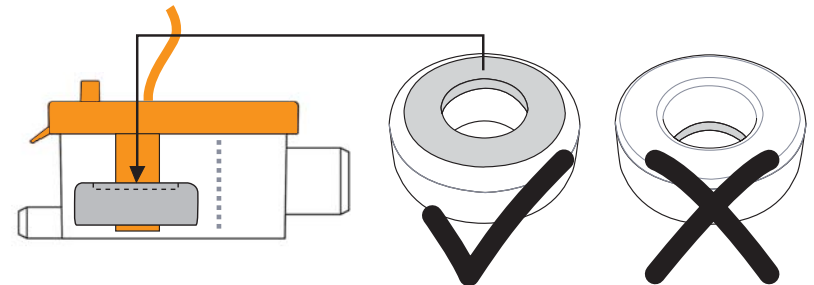

Installation:

4 Secure horizontally. If using reservoir (A), connect firmly to drainage pipe.

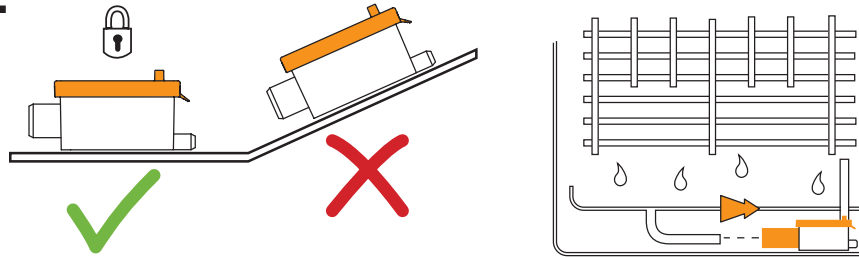

5 Fit breather tube to reservoir lid.

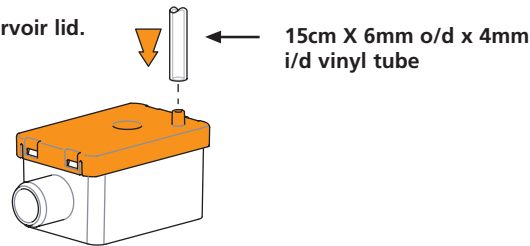

6 Install pump drive unit, above the ceiling where possible. Use sound dampening.

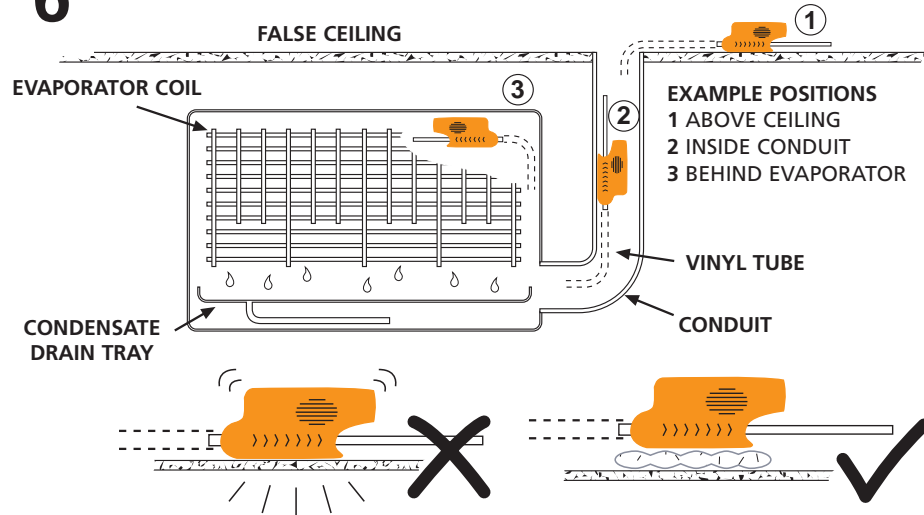

7 Note direction of water flow.

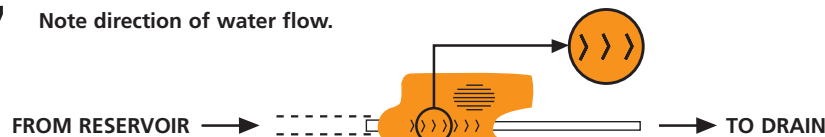

Installation:

8 Plug reservoir sensor cable into pump unit. Push the 6mm o/d x 9mm i/d tube onto the reservoir and the pump. Secure with cable-ties. Ensure length is under 2 metres.

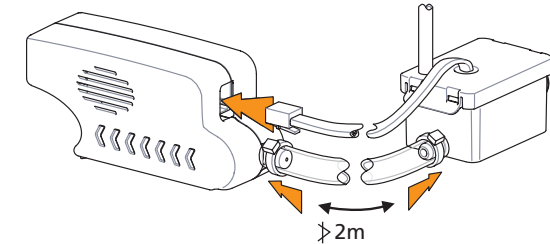

9 Using the adaptor, connect the 6mm o/d pump outlet tube to the 9mm o/d discharge tube. Channel discharge tube to an appropriate drain.

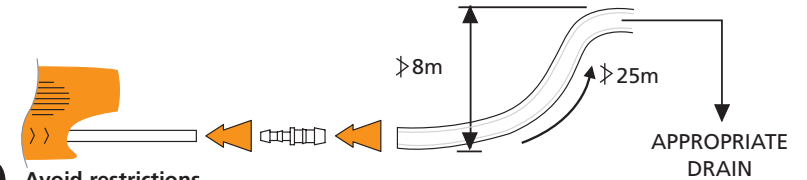

10 Avoid restrictions.

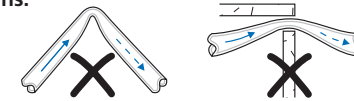

11 Wire the Mini Orange Pump to the permanent Live, Neutral and Earth terminals of the Evaporator. Install a 1.0 amp in-line fuse between the Mini Orange Pump and the Evaporator.

A high-level alarm switch should be wired into the cooling signal wire, to prevent the continued operation of the Air-conditioning unit in the event of the pump failing. These are volt-free contacts and operate as follows:
COMMON AND NORMALLY CLOSED when the water rises to the alarm level the circuit opens.
COMMON AND NORMALLY OPEN when the water rises to the alarm level the circuit closes.

12 TEST pump operation by pouring water into evaporator tray. Check for leaks.

